

- Notes: (Unless Otherwise Specified).
- 1) ALL DIMENSIONS ARE IN MM.
 - 2) SOLDER BALL ALLOY: SEE PART NUMBER TABLE.
 - 3) BALL DIAMETER (BEFORE REFLOW) 0.635mm.
 - 4) SOLDER MASK DEFINED PAD OPENING: 0.508mm [20mil].
 - 5) PAD Cu DIAMETER: 0.635mm [25MIL].
 - 6) DUMMY DIE. Si (SILICON).
 - 7) DAISY CHAIN PATTERN (SEE PAGE 2).
 - 8) MSL-3 RECOMMENDED BAKING 24 HOURS @ 125°C TO REMOVE MOISTURE PRIOR TO SOLDERING TO PC BOARD.

D5 FH'BI A69F H56 @				
D5 FH'BI A69F	65 @@A9H5 @	65 @@5 @@CM	Fc < G	GJ'8 9
SBGA1517T1.0C-DC397D	Sn96.5/Ag3.0/Cu0.5	SAC305	YES	YES
SBGA1517T1.0-DC397D	Sn63/Pb37	Sn63	NO	YES

APPROVALS	DATE				
DRAWN T.Au	7/30/2021				
ENG M. Hart	7/30/2021	TITLE SBGA1517T1.0-DC397D DAISY CHAIN DUMMY			
MFG		SCALE 2:1	SIZE A	DRAWING NO. 513974	REV A
QA		DO NOT SCALE DRAWING			SHEET 1 OF 7
CUST					
REVISED					

65 @@J-9K

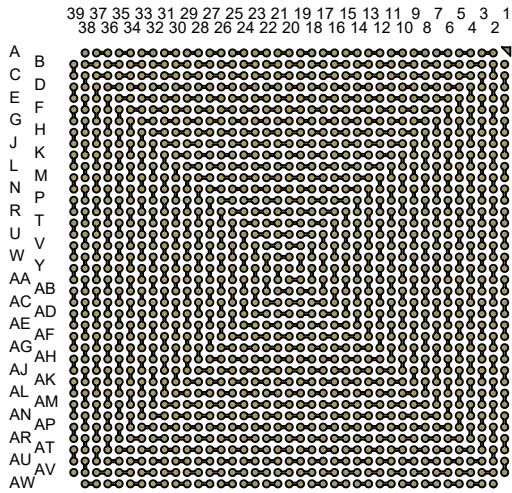

6 CHCA 'G-89 'fHCD'LIF5 MJ-9K L

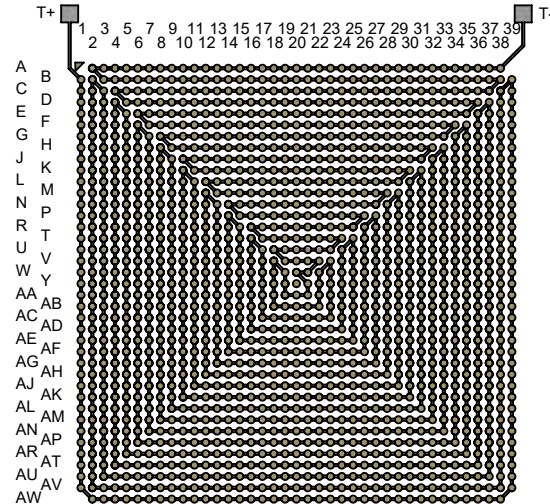
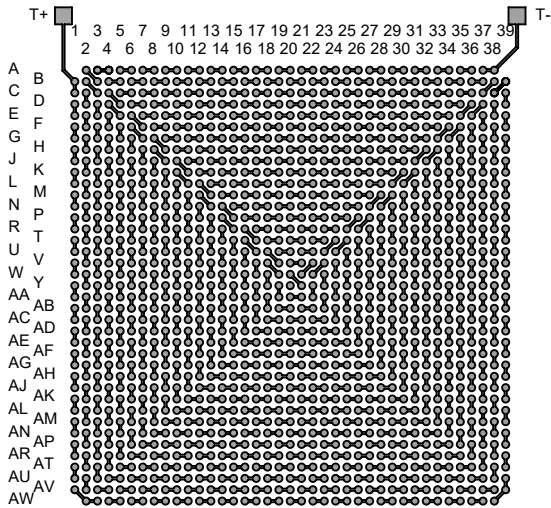
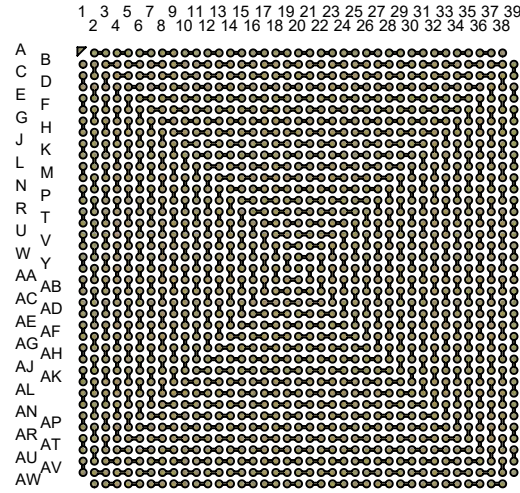

H9GH'J9<=7 @'6C5F8

5: H9F'ACI BH-B;

Notes:

- PCB BOARD DIMENSIONS ARE PRESENTED ONLY AS A GUIDELINE
- DESIGNERS SHOULD USE THEIR OWN KNOWLEDGE WHEN DESIGNING THE PCB.
- PCB Cu BALL PAD DIAMETER: 0.635mm [25mil].
- PCB DAISY CHAIN TRACING LINE WIDTH: 0.203mm [8mil].
- SMD (SOLDER MASK DEFINED) PAD OPENING: 0.508mm [20mil].



TITLE			
SBGA1517T1.0-DC397D DAISY CHAIN DUMMY			
SCALE	SIZE	DRAWING NO.	REV
2:1	A	513974	A
DO NOT SCALE DRAWING			SHEET 2 OF 7

65 @@J-K

39 38 37 36 35 34 33 32 31 30 29 28 27 26 25 24 23 22 21 20 19 18 17 16 15 14 13 12 11 10 9 8 7 6 5 4 3 2 1

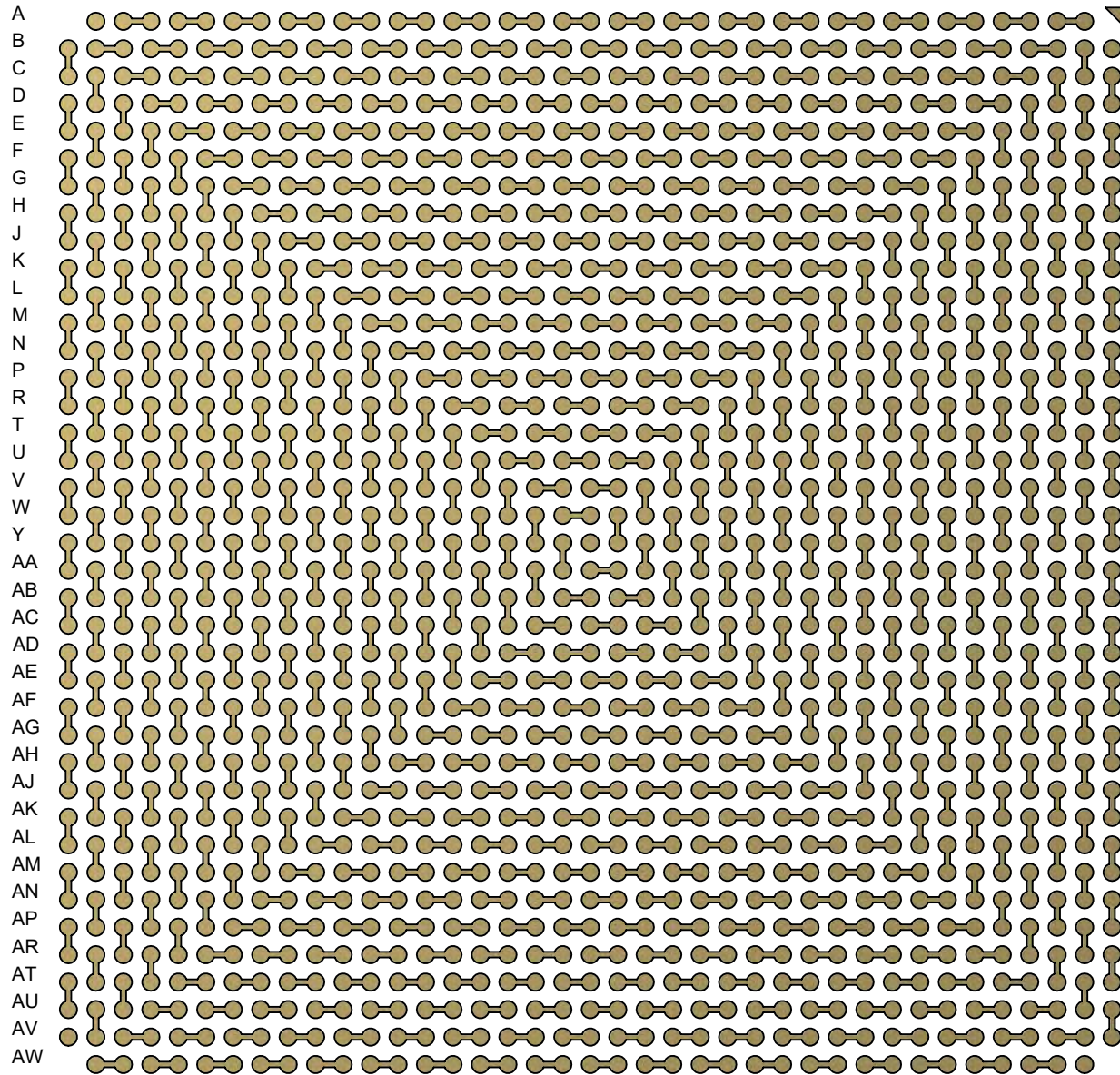

TopLine[®]

TITLE SBGA1517T1.0-DC397D
DAISY CHAIN DUMMY

SCALE 2:1	SIZE A	DRAWING NO. 513974	REV A
--------------	-----------	-----------------------	----------

6 CHHCA 'G-89 fHCD'L!F5 MJ-9K Ł

1 2 3 4 5 6 7 8 9 10 11 12 13 14 15 16 17 18 19 20 21 22 23 24 25 26 27 28 29 30 31 32 33 34 35 36 37 38 39

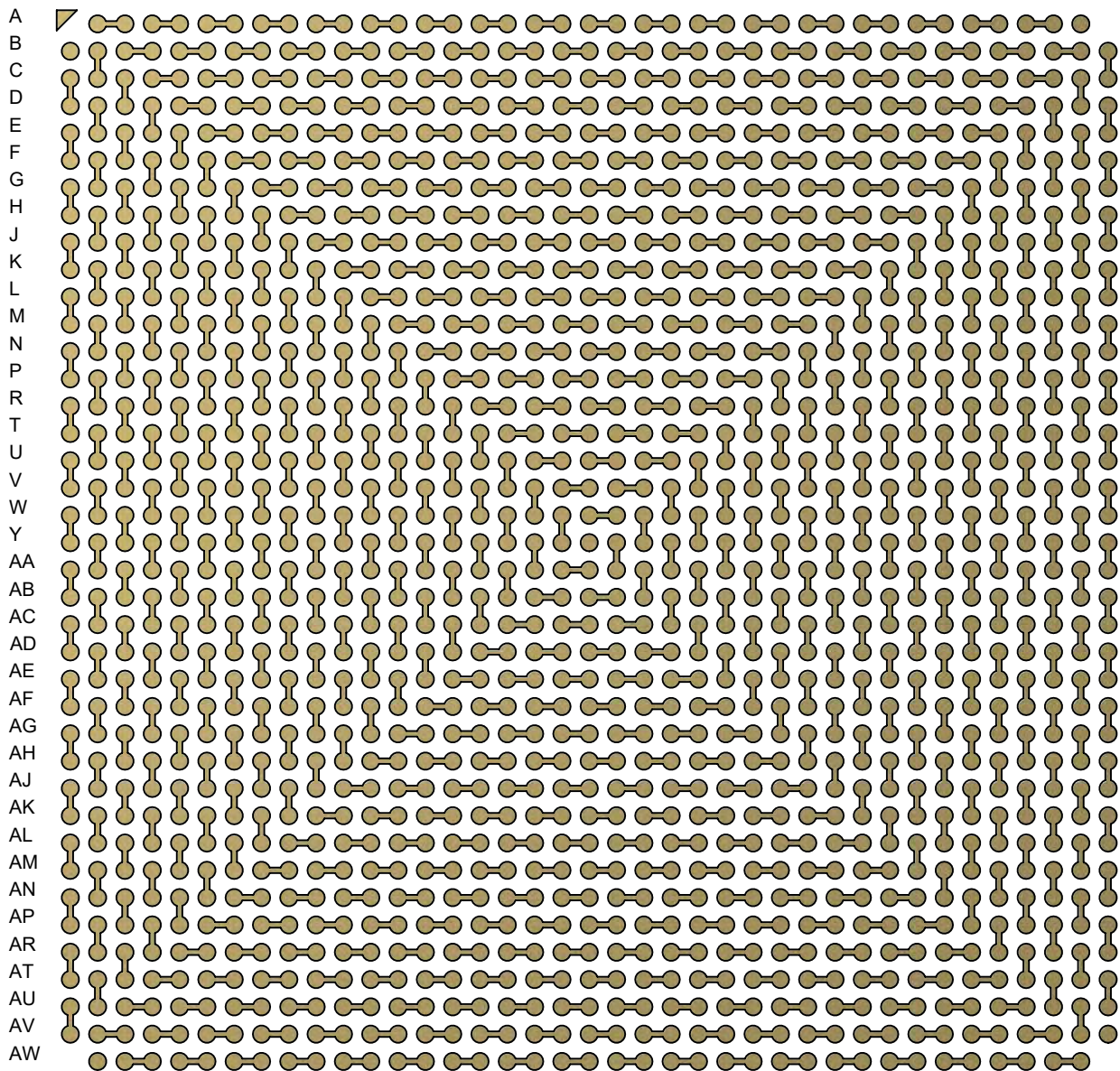

TITLE			
SBGA1517T1.0-DC397D DAISY CHAIN DUMMY			
SCALE	SIZE	DRAWING NO.	REV
2:1	A	513974	A
DO NOT SCALE DRAWING			SHEET 4 OF 7

<95 H'GDF9589F

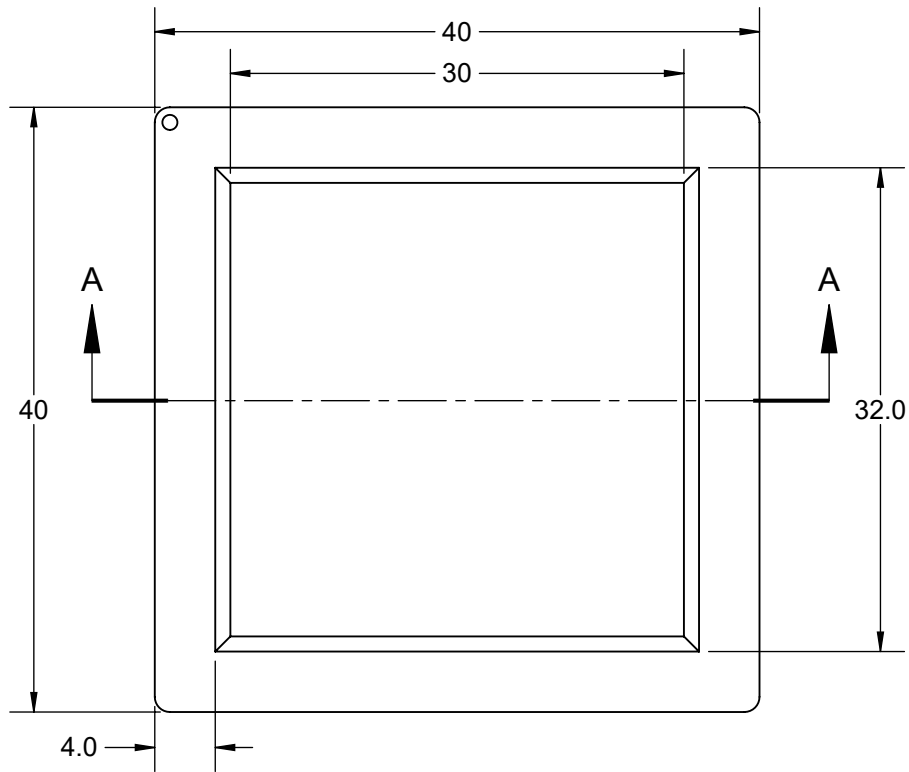

HCD

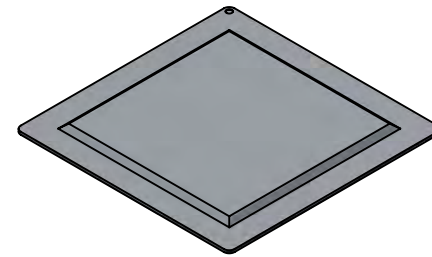

AC89@

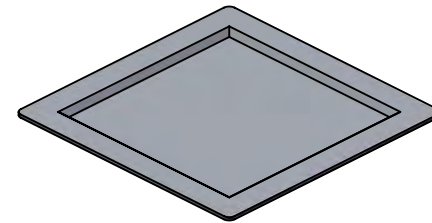

75 J#M

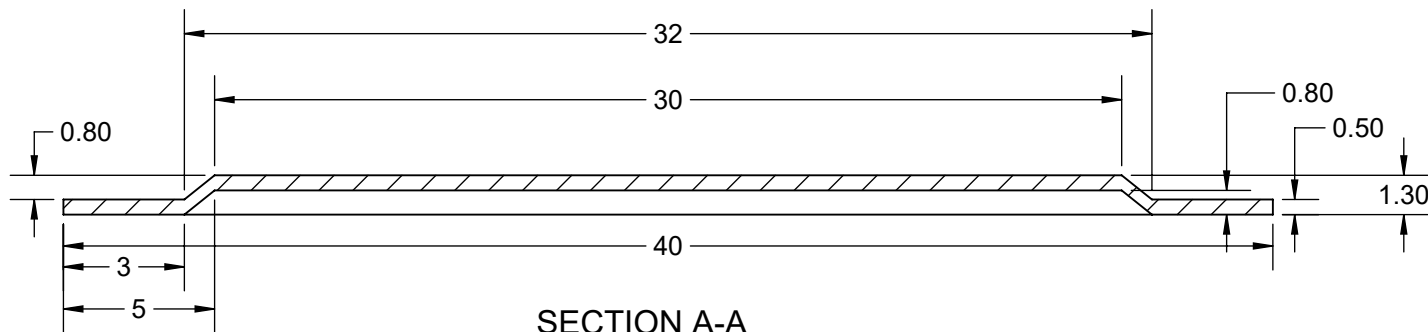

SECTION A-A
SCALE 4 : 1

TopLine®

TITLE SBGA1517T1.0-DC397D
DAISY CHAIN DUMMY

SCALE	SIZE	DRAWING NO.	REV
3:2	A	513974	A

DO NOT SCALE DRAWING

SHEET 5 OF 7

AC89@

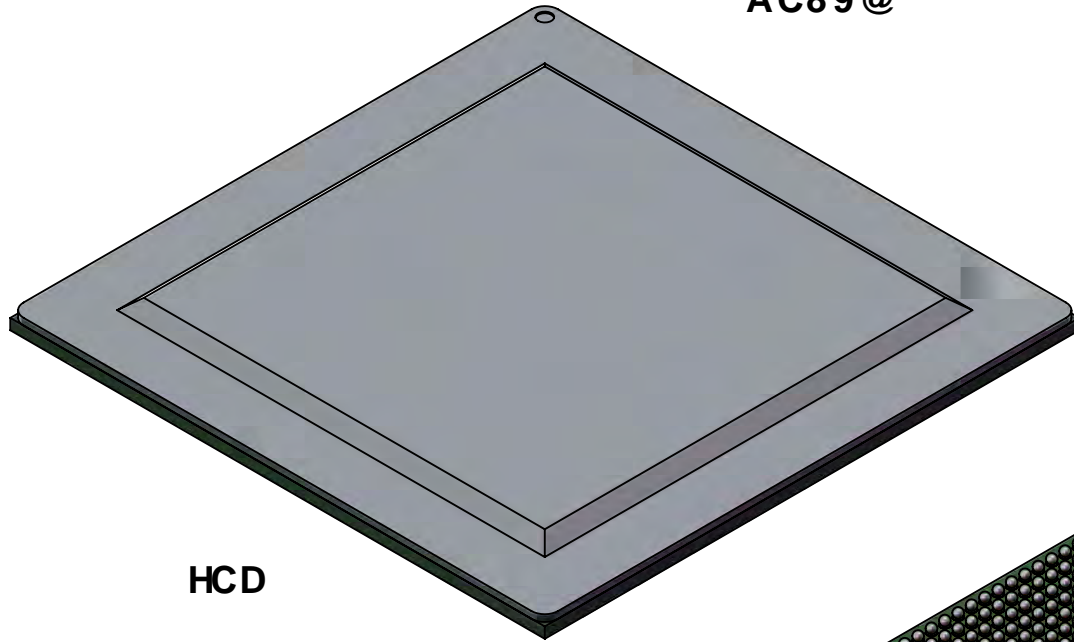

HCD

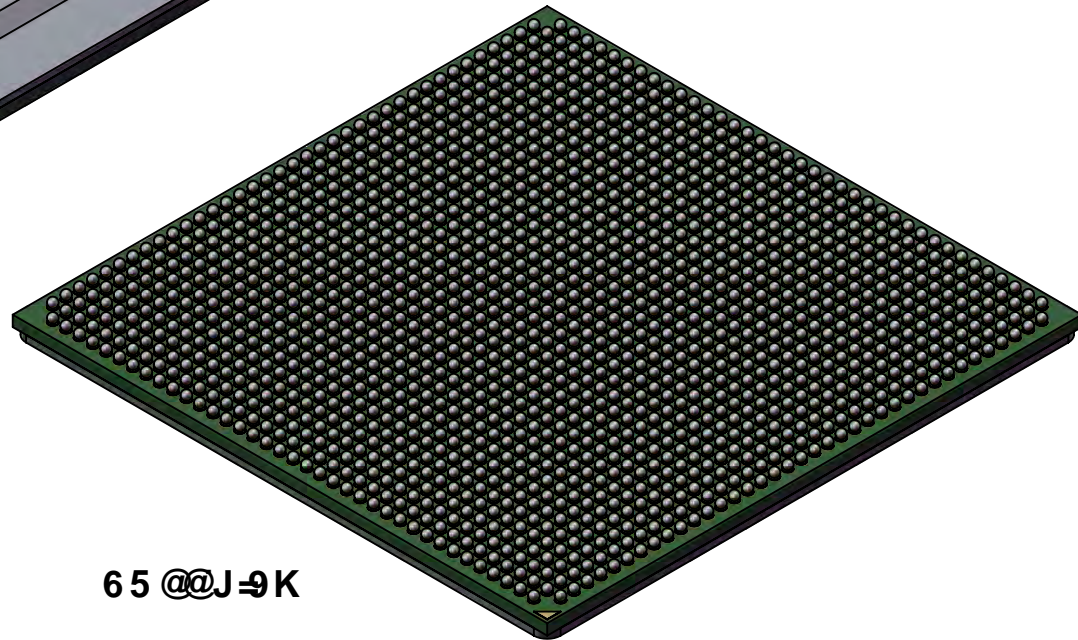

65 @@J=9K

TopLine[®]

TITLE SBGA1517T1.0-DC397D
DAISY CHAIN DUMMY

SCALE 2:1	SIZE A	DRAWING NO. 513974	REV A
--------------	-----------	-----------------------	----------

DO NOT SCALE DRAWING

SHEET 6 OF 7

6 CHHCA GC @ 9FA5 G?
 'ff = <HF958 B; L

39 38 37 36 35 34 33 32 31 30 29 28 27 26 25 24 23 22 21 20 19 18 17 16 15 14 13 12 11 10 9 8 7 6 5 4 3 2 1

A
B
C
D
E
F
G
H
J
K
L
M
N
P
R
T
U
V
W
Y
AA
AB
AC
AD
AE
AF
AG
AH
AJ
AK
AL
AM
AN
AP
AR
AT
AU
AV
AW

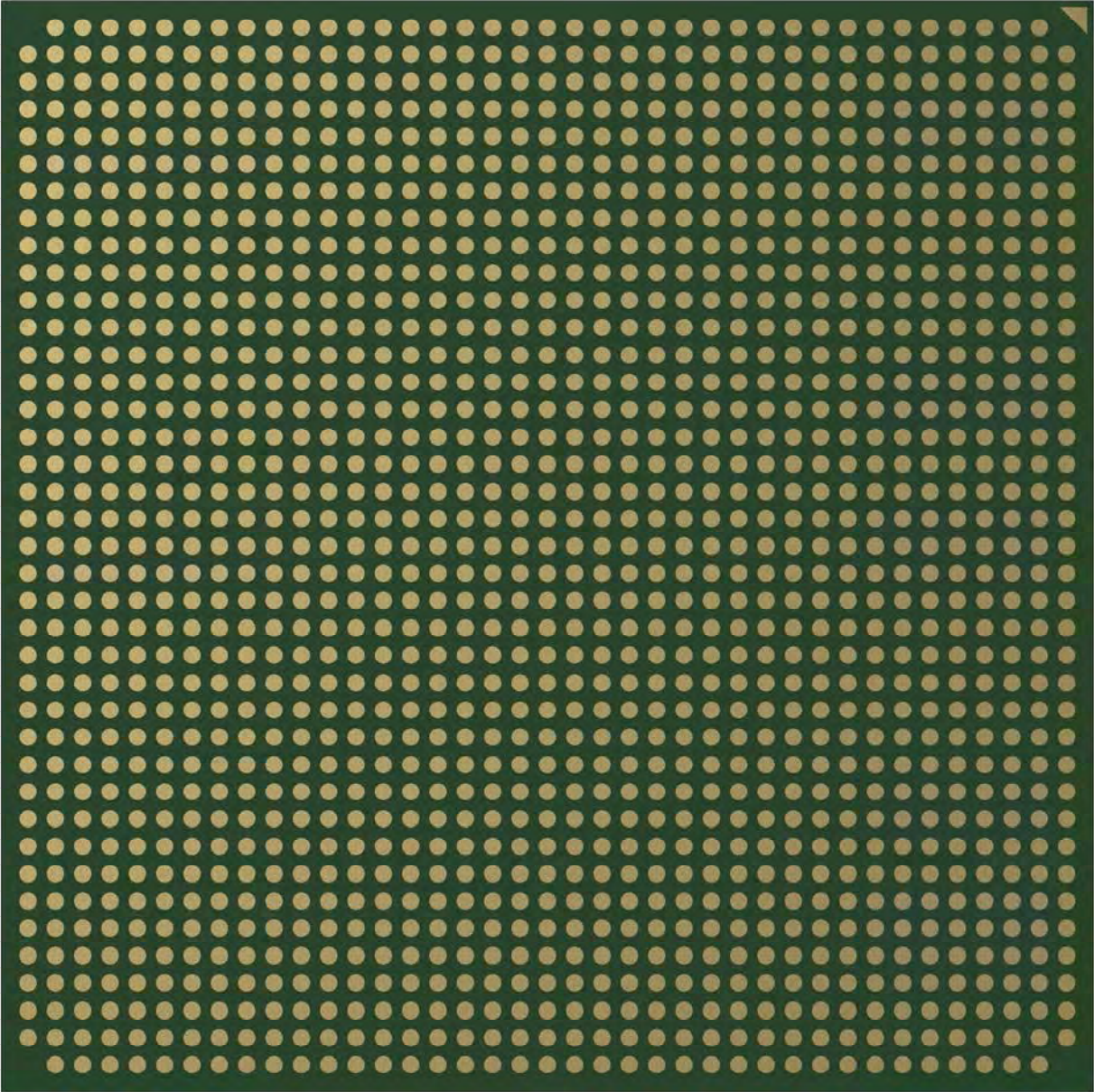

TopLine®			
TITLE		SBGA1517T1.0-DC397D DAISY CHAIN DUMMY	
SCALE	SIZE	DRAWING NO.	REV
2:1	A	513974	A
DO NOT SCALE DRAWING			SHEET 7 OF 7